The JBL logo is displayed in white, bold, sans-serif capital letters within a black square. The 'J' and 'L' are stylized with a vertical line through them.

®

GTO24001

OWNER'S MANUAL

**BEDIENUNGS-
ANLEITUNG**

MODE D'EMPLOI

MANUAL DE USO

HANDLEIDING

MANUALE UTENTE

**ANVÄNDAR-
HANDBOK**

BRUGSVEJLEDNING

**OMISTAJAN
KÄSIKIRJA**

**PODRECZNIK
UZYTKOWNIKA**

**РУКОВОДСТВО
ПОЛЬЗОВАТЕЛЯ**

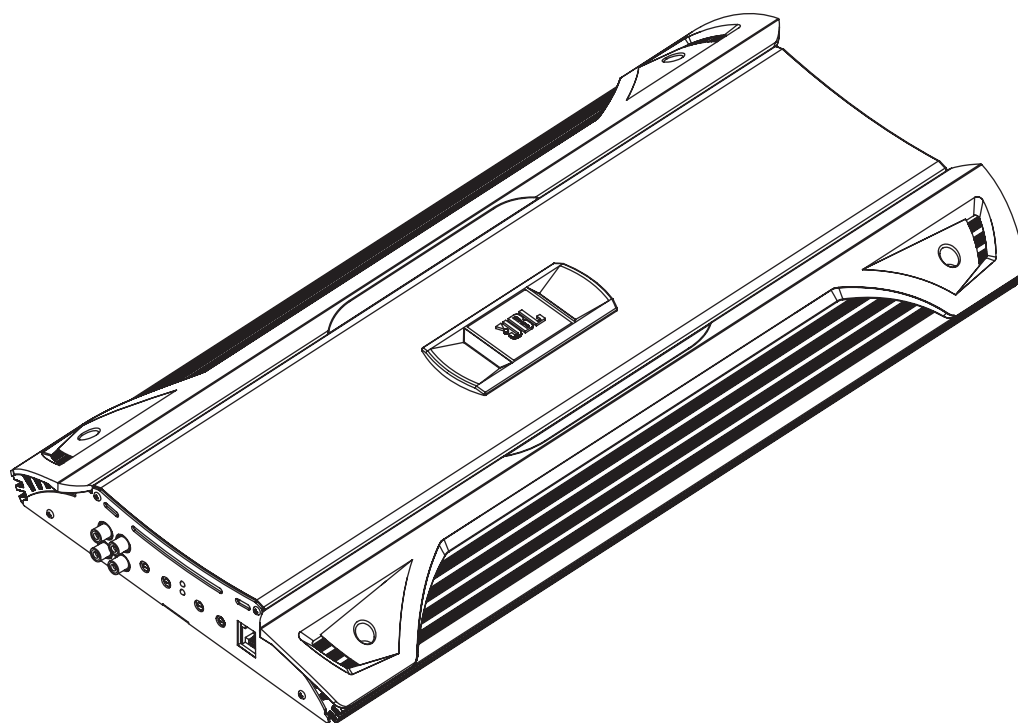

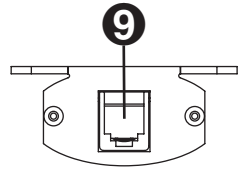
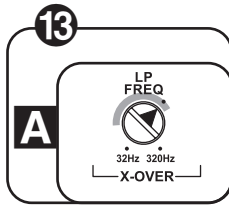
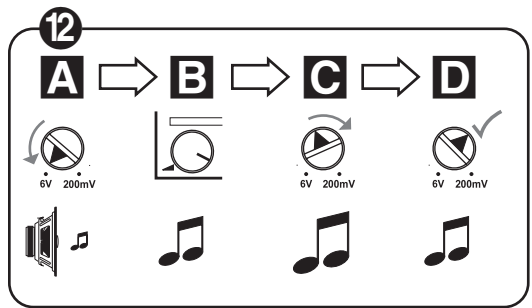
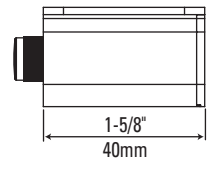
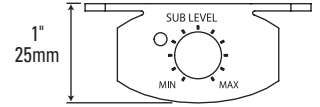
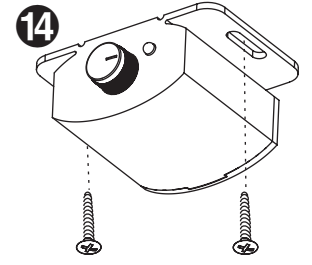
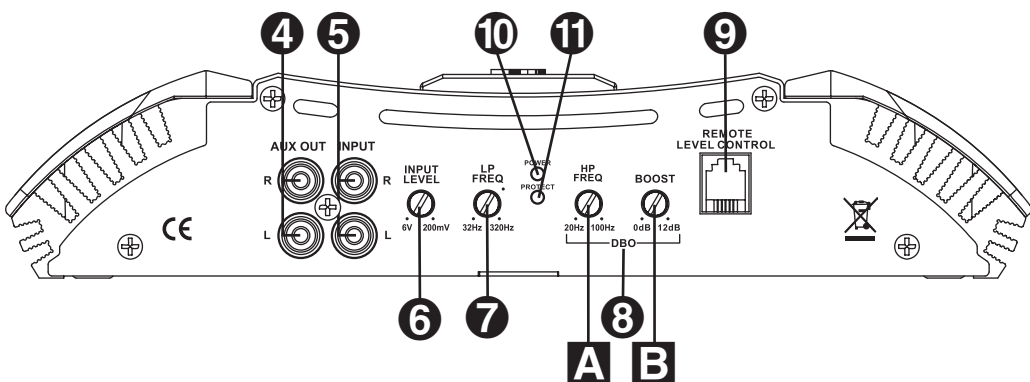
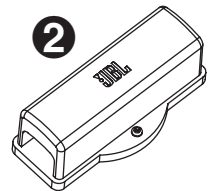
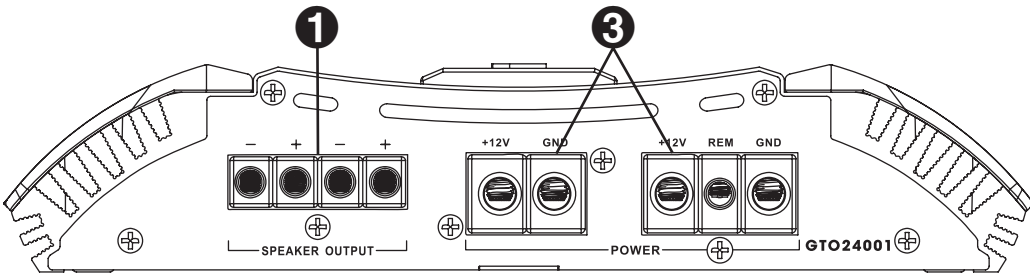
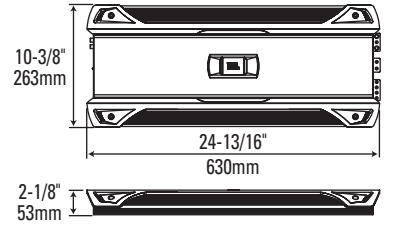
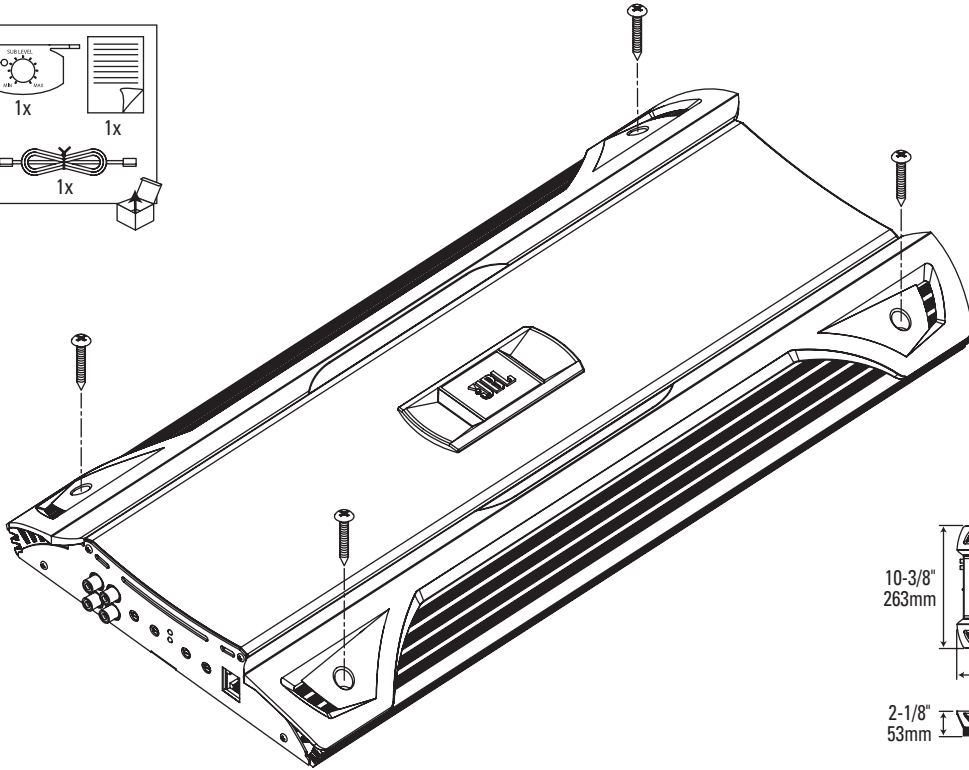
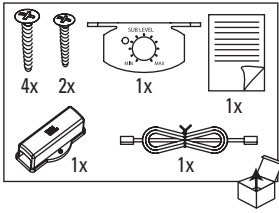

GTO24001 CAR AUDIO SUBWOOFER AMPLIFIER OWNER'S MANUAL

Installation Warnings and Tips

- Disconnect the negative (-) lead from your vehicle's battery.
- At the installation sites, locate and make a note of all fuel lines, hydraulic brake lines, vacuum lines and electrical wiring. Use extreme caution when cutting or drilling in and around these areas.
- Choose a safe mounting location away from moisture.
- Make sure there is sufficient air circulation at the mounting location for the amplifier to cool itself.
- Mount the amplifier, using the supplied hardware.

Specifications

- 1700W RMS x 1 channel @ 4 ohms and $\leq 1\%$ THD + N*
 - 2400W RMS x 1 channel @ 2 ohms, 14.4V supply and $\leq 1\%$ THD + N*
 - Frequency response: 20Hz – 330Hz (-3dB)
 - Maximum input signal: 6V*
 - Maximum sensitivity: 200mV*
 - THD + N: 0.5%
 - Signal-to-noise ratio: 65dBA (reference 1W into 4 ohms)*
 - Signal-to-noise ratio: 97dBA (reference rated power into 4 ohms)
- * CEA-2006A-compliant

1 Speaker Output Connectors

- Connect the speakers to these terminals, observing proper polarity. Either + or - terminal may be used. Minimum total impedance is 2 ohms.

2 Fuse Holder

- Replace fuse only with the same type and rating.
- Mount the included fuse holder within 18" of the vehicle's battery. Connect one terminal of the holder to the battery's positive (+) terminal. Connect the other terminal of the fuse holder to the amplifier as in 3, below. 0 AWG wire is recommended. Make sure the wire is not damaged or pinched during installation. Install protective grommets when routing wires through the firewall or other sheet metal.

3 Power Input Connectors

- +12V: Connect to the unused terminal of the included fuseholder.
- GND: Connect to the vehicle's chassis. Refer to the picture below.

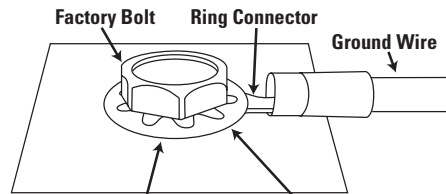

Note: Remove any paint below ring connector.

- REM: Connect to the "Remote Out" lead from the source unit or to a source of switched 12V+ (ACC).

4 Aux Output Connectors (RCA)

- Nonfiltered pass-through output. Connect to the input of an additional amplifier.

5 Input Connectors (RCA)

- Connect to the RCA outputs from the source unit or signal processor.

6 Input-Level Control

- Used to match the input level of the amplifier to the output level of the source unit.
- See 12 for the adjustment procedure.

7 Low-Pass Filter Frequency Control

- 12dB/octave low-pass filter, variable from 32Hz to 320Hz.
- See 18 for the adjustment procedure.

8 DBO (Dynamic Bass Optimization)

Variable Subsonic High-Pass Filter With Variable Boost (Q)

- For woofers in tuned (vented) enclosures, set the Frequency control to a value 10Hz below the enclosure's resonance (tuned) frequency.
- For woofers in sealed boxes, set the control to any value you prefer, between 30Hz and 50Hz.
- Set the Boost control according to your preference, being careful not to apply enough boost to damage your woofer(s).
 - A** DBO High-Pass Filter Frequency control, variable between 10Hz and 100Hz. See above for appropriate settings.
 - B** DBO Boost control provides up to 12dB of boost, slightly above the high-pass filter's frequency. See above for appropriate settings.

9 Remote Level Control (RLC) Connector

- Connect the Remote Level Control (RLC) here, using the supplied RJ-11 cable.

10 Power On LED

- Illuminated when the amplifier is on.

11 Protect LED

- Illuminated under any of the following fault conditions: battery over/under voltage, short circuit in speaker wires, amplifier is too hot, amplifier's output circuit has failed (DC voltage is present in the amplifier's output).

12 Setting Input Level

- A** Turn Input Level control counterclockwise to 6V (minimum).
- B** With a dynamic music track playing, turn the head unit's volume control to the 3/4 position.
- C** Turn Input Level control clockwise until the bass output is proportionate to the output of the high-frequency speakers, according to your preference.
- D** Input level is now adjusted correctly.

13 Setting the Crossover

- A** Crossover setting for subwoofers.

Note: Acceptable frequency ranges are indicated in gray.

14 Remote Level Control

The Remote Level Control, if installed, will allow you to adjust the level of bass while seated in the listening position.



Harman Consumer Group, Inc.
250 Crossways Park Drive, Woodbury, NY 11797
www.jbl.com

© 2008 Harman International Industries, Incorporated. All rights reserved.

JBL is a trademark of Harman International Industries, Incorporated,
registered in the United States and/or other countries.

Part No. GT0240010M 6/08

H A Harman International Company



Declaration of Conformity

CE

We, Harman Consumer Group, Inc.
2, route de Tours
72500 Château du Loir
France

declare in own responsibility that the product described in this owner's
manual is in compliance with technical standards:
EN 55013:2001+A1:2003
EN 55020:2002+A1:2003

Klaus Lebherz
Harman Consumer Group, Inc.
Château du Loir, France 6/08